

Part	Link	Unit Cost	Qty	Total Cost	ETA	Notes
Cart						
Low-Profile Laminate-Top Table	McMaster Link	\$100.00	1	\$100.00	2-3 days	
Hanger Rails for Depth (#SI-AHR12C-D) - 12"	Shelving Link	\$3.68	4	\$14.72	1-3 weeks	Needed to attach cart handle
Utility Cart Handle (#SI-AUCH18C) - 18"	Shelving Link	\$19.97	1	\$19.97	1-3 weeks	
Record Player						
Stanton STR8.150	Ebay Link	\$299.00	1	\$299.00	N/A	Other Options: Stanton ST.150 MKII (New) Numark NTX1000 (New) Stanton T120 (Used - Ebay) Numark TTX (Used - Ebay) Numark TT200 (Used - Ebay)
Tanks						
Square Tank (OPTIONAL)	Tank Quote	\$375.00	0	\$0.00	1-2 weeks	Drawings provided for local sourcing. Includes 25% educational discount
Circular Tank (OPTIONAL)		\$596.25	0	\$0.00		
Elevation Blocks	McMaster Link	\$4.53	4	\$18.12	2 days	Requires your own tank
Tools and Accessories						
Mallet	McMaster Link	\$13.50	1	\$13.50	2 days	Needed to put the cart together
Suaoki 150Whr	Amazon Link	\$125.99	1	\$125.99	1 week	Power for record player
				Subtotal:	\$591.30	



ESTIMATE

SoCal Plastics Pro

Henry Gonzalez
1707 W Pico Blvd.
Los Angeles, CA 90015
United States

Phone: +1 818-912-0554
scplasticspro@gmail.com
www.socalplasticspro.com

Estimate #: 2415
Estimate date: Sep 28, 2020

Description	Quantity	Price	Amount
Clear Square Tank - Custom Base to fit NuMark NTX1000 Turntable 12"L x 12"W x 12"H [Include lid for convection] 3/8" Clear Cast Walls & 3/8" White Base	1	\$500.00	\$500.00
Clear Cylindrical Tank - Custom Base to fit NuMark NTX1000 Turntable 12" O.D. x 11"H [Include lid for convection] 1/4" Clear Cast Walls & 3/8" White Base	1	\$795.00	\$795.00
		Subtotal	\$1,295.00
		Total	\$1,295.00

Notes

Cancellation - the contract resulting from the acknowledgment and acceptance of Buyer's order cannot be canceled, terminated or modified by Buyer in whole or in part except with Seller's consent in writing and then only upon terms and conditions then to be agreed upon which shall include protection of Seller against all loss.

Terms and Conditions

Claims; Disclaimer of Warranties - products may not be returned except by written permission of Seller. Buyer assumes all risk and liability for loss, damages or injury to person or to the property of the Buyer or others arising out of the use or presence of the materials purchased hereunder. Buyer agrees to indemnify and hold harmless Seller against any liability, damages, losses, costs, and expenses in connection with any suit or claim; including but not limited to, any loss of use, loss of profits, damage or injuries to persons or property arising out of or relating to any use of materials purchased by Buyer herein, whether such claim is made by Buyer, Buyer's customers, or other third parties.

2 1

B

B

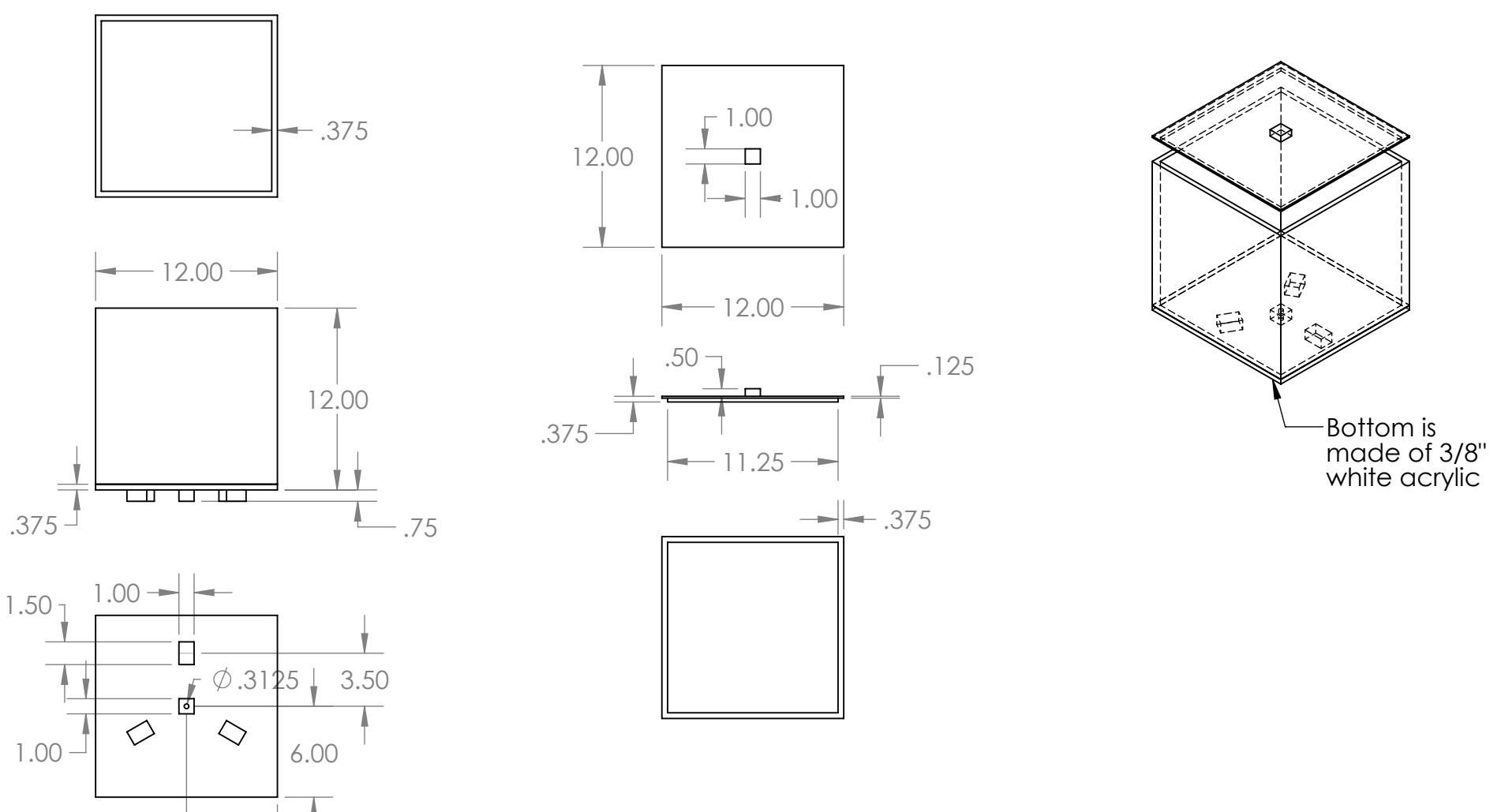

A

A

PROPRIETARY AND CONFIDENTIAL
 THE INFORMATION CONTAINED IN THIS DRAWING IS THE SOLE PROPERTY OF <INSERT COMPANY NAME HERE>. ANY REPRODUCTION IN PART OR AS A WHOLE WITHOUT THE WRITTEN PERMISSION OF <INSERT COMPANY NAME HERE> IS PROHIBITED.

		UNLESS OTHERWISE SPECIFIED:		NAME	DATE
		DIMENSIONS ARE IN INCHES	DRAWN		
		TOLERANCES:	CHECKED		
		FRACTIONAL ±	ENG APPR.		
		ANGULAR: MACH ± BEND ±	MFG APPR.		
		TWO PLACE DECIMAL ±	Q.A.		
		THREE PLACE DECIMAL ±	COMMENTS:		
		INTERPRET GEOMETRIC TOLERANCING PER:			
		MATERIAL			
		Acrylic (clear and white)			
		FINISH			
NEXT ASSY	USED ON				
APPLICATION		DO NOT SCALE DRAWING			

TITLE:		
Square Tank DJ Table		
SIZE	DWG. NO.	REV
A	Square	1
SCALE: 1:10 WEIGHT:		SHEET 1 OF 1

B

B

A

A

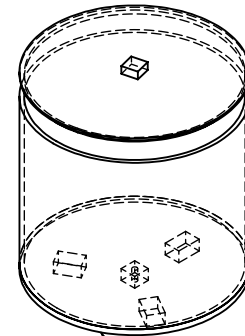
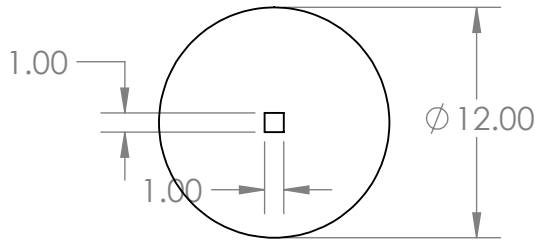
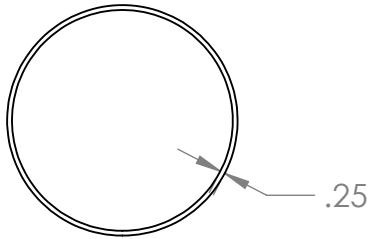

Bottom is made of 3/8" white acrylic

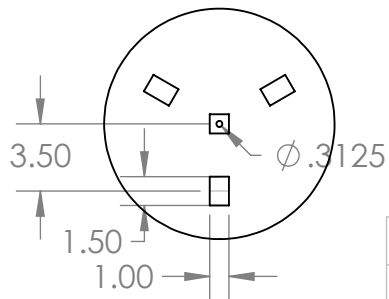
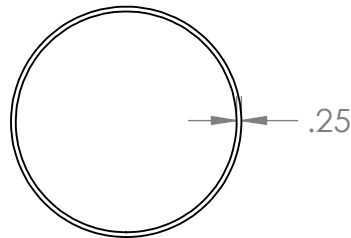
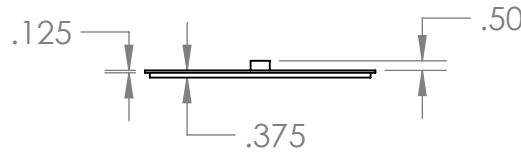
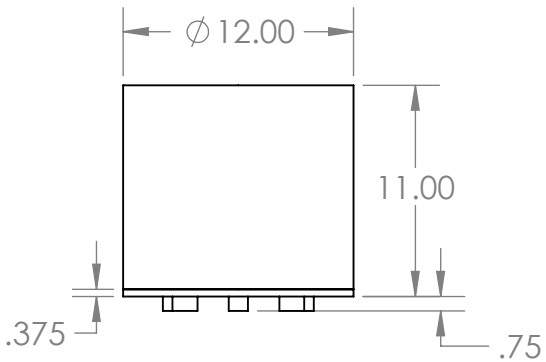

PROPRIETARY AND CONFIDENTIAL
 THE INFORMATION CONTAINED IN THIS DRAWING IS THE SOLE PROPERTY OF <INSERT COMPANY NAME HERE>. ANY REPRODUCTION IN PART OR AS A WHOLE WITHOUT THE WRITTEN PERMISSION OF <INSERT COMPANY NAME HERE> IS PROHIBITED.

		UNLESS OTHERWISE SPECIFIED:		NAME	DATE
		DIMENSIONS ARE IN INCHES	DRAWN		
		TOLERANCES:	CHECKED		
		FRACTIONAL ±	ENG APPR.		
		ANGULAR: MACH ± BEND ±	MFG APPR.		
		TWO PLACE DECIMAL ±	Q.A.		
		THREE PLACE DECIMAL ±	COMMENTS:		
		INTERPRET GEOMETRIC TOLERANCING PER:			
		MATERIAL			
		Acrylic (white and clear)			
		FINISH			
NEXT ASSY	USED ON				
APPLICATION		DO NOT SCALE DRAWING			

TITLE:		
Circle Tank DJ Table		
SIZE	DWG. NO.	REV
A	Circle	1
SCALE: 1:10 WEIGHT:		SHEET 1 OF 1